

Technical Information

911 Turbo (993) 9
2/01 9752

Binder - Service Technical Bulletins

W301-Replacement of Engine Wiring Harness

Vehicle Type: 911 Turbo (993)

Model Year: MY 1996 (T)

Concern: Engine wiring harness

Information: Porsche is requesting that the engine wiring harness be checked and/or replaced on a certain range of model year 1996 911 Turbo (993) vehicles.

Based on field information and internal testing, Porsche AG has concluded that the insulation of the wires of the wiring harness may deteriorate. The deterioration of multiple wires may result in shorts which affect the proper function of the engine. Rough engine running, stalling, inability to start the engine due to a dead battery, starter malfunction, and illumination of the Malfunction Indicator Light ("Check Engine" warning lamp) are symptoms for this problem.

The engine wiring harness part number must be checked on all affected vehicles. Depending on what you find when you inspect the vehicle, the wiring harness may then also need to be replaced.

Affected Vehicles: A total of 779 U.S. and 65 Canadian vehicles fall within the scope of this Service Action.

Very Important! Not every vehicle in the below listed range may be affected. Use the ranges below as a general guideline. Alternatively, the VIN can be checked in the Porsche E-DCS/WWS for confirmation of an open service action (or recall campaign). Also, the VIN can be checked via the VRU (Voice Response System) for any open listing.

The affected Vehicle Identification Numbers are **contained** in the following VIN-Ranges:

WPOAC2992TS375065 to WPOAC2992TS375924 (U.S. Vehicles)
WPOAC2996TS375067 to WPOAC299XTS375895 (Canadian Vehicles)

Customer Notification

Porsche Cars North America, Inc. will notify all known Vehicle Owners directly by First Class Mail during the week of October 21, 2002, as per attached Notification Card located in Attachment "A"

9 911 Turbo (993)
9752 2/01

Technical Information

Work Procedure: See Attachment "B".

Administrative Procedure: See Attachment "C"

Customer Reimbursement Procedure: See Attachment "D"

Parts Required:	Part Number	Quantity	Description
	000 043 204 62	1	Part set for Turbo engine Contains: 1x - Engine wiring harness (993 607 016 12) 1x - Adapter for heating connector (connected to wiring harness) 3x - Tie wrap
	964 110 227 00	1	Seal
	999 707 326 40	2	O-ring
	999 512 460 00	1	Single-lug clamp

PORSCHE®

Technical Information

911 Turbo (993)
2/01 9752

9

Attachment "A" Customer Notification Card

SERVICE ACTION NOTICE

Re: W301 Customer Service Campaign Action

Dear Porsche Owner:

Our records indicate that you are the Owner of a Porsche 911 Turbo (993), model year 1996 vehicle that may be affected by a Workshop Service Action concerning the engine wiring harness.

Porsche AG, initiated this voluntary customer service campaign action based on field information and internal testing, and concluded that the insulation of the wires of the harness may deteriorate. Deterioration of multiple wires may result in shorts which affect the proper function of the engine. Rough engine running, stalling, inability to start the engine due to dead battery, starter malfunction, and illumination of the Malfunction Indicator Light ("Check Engine" Warning Lamp) are symptoms for this problem.

In order to avoid such faults arising, the engine wiring harness of your Porsche must be checked. Depending on the results of these checks, the wiring harness may then also need to be replaced.

You should arrange for an appointment with your Porsche dealer as soon as possible to have the required work performed. The necessary parts to perform this service campaign action will be available at your Porsche dealer. The estimated time to perform the repair is approximately six to eight hours and will be completed at no charge to you. Please allow yourself and your Porsche dealer additional time to complete the repairs.

If you have already paid for the engine wiring harness of your Porsche to be replaced or repaired due to this particular problem, you will still need to have your vehicle inspected. Please send all documents in the enclosed postage-paid envelope for our review. The costs that you previously incurred may be reimbursable to you.

If your Porsche dealer is unable to perform this repair within a reasonable period of time, you may call or write:

Porsche Cars North America, Inc.
980 Hammond Drive, Suite 1000
Atlanta, Georgia 30328

Attention: Customer Commitment
Telephone: 1-800-Porsche (767-7243)

We sincerely regret any inconvenience this Customer Campaign may cause, and hope you understand our interest in performing this work promptly so that you can be satisfied with your Porsche automobile. Please accept our apologies for this unplanned service visit.

Sincerely, Porsche Cars North America, Inc.



NO POSTAGE
NECESSARY
IF MAILED
IN THE
UNITED STATES

BUSINESS REPLY CARD
FIRST CLASS PERMIT NO. 26231 ATLANTA, GA

POSTAGE WILL BE PAID BY ADDRESSEE

Porsche Cars North America, Inc.
Attn: Customer Commitment
980 Hammond Drive, Suite 1000
Atlanta, Georgia 30328-9735



9 911 Turbo (993)
9752 2/01

Technical Information

Attachment "A" Customer Notification Card
(cont'd)

PORSCHE®																															
Porsche Cars North America, Inc. 980 Hammond Drive, Suite 1000 Atlanta, Georgia 30328																															
SERVICE ACTION NOTICE																															
Vehicle Identification Number	Recall W301	Dealer #																													
<p>If you no longer own this automobile or your address is different from that shown below, please complete this postage pre-paid card, detach and return.</p> <p><input type="checkbox"/> My correct address is: or <input type="checkbox"/> I sold this vehicle to:</p> <table style="width: 100%; border-collapse: collapse;"> <tr> <td style="border: 1px solid black; width: 33%; height: 20px;"></td> <td style="border: 1px solid black; width: 33%; height: 20px;"></td> <td style="border: 1px solid black; width: 33%; height: 20px;"></td> </tr> <tr> <td style="font-size: small;">Last Name</td> <td style="font-size: small;">First Name</td> <td style="font-size: small;">Initial</td> </tr> <tr> <td style="border: 1px solid black; height: 20px;"></td> <td colspan="2" style="border: 1px solid black; height: 20px;"></td> </tr> <tr> <td style="font-size: small;">Number</td> <td colspan="2" style="font-size: small;">Street</td> </tr> <tr> <td style="border: 1px solid black; height: 20px;"></td> <td colspan="2" style="border: 1px solid black; height: 20px;"></td> </tr> <tr> <td style="font-size: small;">City</td> <td style="font-size: small;">State</td> <td style="font-size: small;">Zip</td> </tr> </table> <p> <input type="checkbox"/> Vehicle totaled/scrapped: } <input type="checkbox"/> Vehicle reported stolen: } <input type="checkbox"/> Vehicle has been exported: } </p> <table style="margin-left: auto; margin-right: auto;"> <tr> <td style="border: 1px solid black; width: 20px; height: 20px;"></td> <td style="border: 1px solid black; width: 20px; height: 20px;"></td> <td style="border: 1px solid black; width: 20px; height: 20px;"></td> <td style="border: 1px solid black; width: 20px; height: 20px;"></td> </tr> <tr> <td style="font-size: x-small;">Month</td> <td style="font-size: x-small;">Day</td> <td colspan="2" style="font-size: x-small;">Year</td> </tr> </table> <p style="font-size: x-small; margin-left: 150px;">Please print and give complete information.</p> <table style="width: 100%; border-collapse: collapse; margin-top: 10px;"> <tr> <td style="width: 40%; padding: 5px;"> Vehicle Identification Number </td> <td style="width: 20%; padding: 5px; text-align: center;"> Recall </td> <td style="width: 40%; padding: 5px;"> Dealer # </td> </tr> </table>						Last Name	First Name	Initial				Number	Street					City	State	Zip					Month	Day	Year		Vehicle Identification Number	Recall	Dealer #
Last Name	First Name	Initial																													
Number	Street																														
City	State	Zip																													
Month	Day	Year																													
Vehicle Identification Number	Recall	Dealer #																													

Attachment "B"

Work Procedure: Follow the steps below and refer to the enclosed excerpt from the Technical Manual at the end of this bulletin for the actual work procedure.

1. Check the part number of the engine wiring harness. Use the criteria in section 97-2, page 1 to determine if the wiring harness needs to be replaced.
2. If the part number on the harness matches up with a part number listed in the table located in section 97-2 page 1, the harness needs to be replaced. Replace the harness then go to step 4.
2. If the part number on the harness does not match up with a part number listed in the table located in section 97-2 page 1, the harness does not have to be replaced. Continue with step 4.
4. Enter the campaign in the Warranty and Maintenance book.

Literature: 911 Carrera (993) Technical Manual, Group 9:
> Repairs: 97 52 55 – Replacing the wiring harness for the naturally-aspirated engine (enclosed with this bulletin)

9 911 Turbo (993)
9752 2/01

Technical Information

Attachment "C"

Administrative Procedure, Service Action W301

Engine Wiring Harness

Warranty claims should be submitted via e-dcs

Note: Always check for open recall status under the appropriate e-dcs menu options.

- Affected VINs:** See attachment "A"
- Labor Operation:** Will be automatically inserted along with the necessary parts when the damage code is entered.
- Warranty Code:** R
- Scope 1:** Checking the part number of the engine wiring harness.
- Damage Code:** W301 066 000 1 (for W301)
- Repair Code:** 1
- Time Units:** 80 TU
- Scope 2:** Checking and replacing the engine wiring harness on MY 1996 (T).
- Damage Code:** W301 066 000 1 (for W301)
- Repair Code:** 2
- Time Units:** 640 TU
- Parts:**

Part Number	Qty.	Description
000 043 204 62	1	Wiring Harness Kit
964 110 227 00	1	Seal
999 707 326 40	2	O-ring
999 512 460 00	1	Single-lug clamp

In cases where the recall cannot be performed, submit this information on a claim via e-dcs with the appropriate disposition code by inserting the code in the last digit of the damage code, as shown below.

Disposition/Repair code

- 3 - Total Loss
- 4 - Vehicle Stolen
- 5 - Vehicle left North America
- 6 - Customer Moved/address unknown
- 7 - Vehicle sold, new owner information
- 9 - Customer refused to comply

Owner name and address change

If the owner name and address are shown incorrectly, submit a correction using the name/address postcard from the Warranty Maintenance Booklet (or Recall mailing), or report the change to the Warranty Department via e-dcs, including VIN.

Attachment D: Reimbursement to customer for previously repaired vehicles.

Important! The harness check must be performed before we will reimburse the customer.

The customer was sent a form and a postage paid envelope with the Service Action notification. The customer must completely fill out the form, attach the appropriate receipts, and mail it to PCNA to be considered for reimbursement. PCNA will not be responsible to reimburse for incidental expenses related to the wire harness replacement.

The customer must follow these steps to be considered for reimbursement:

1. Repair order in which the harness replacement is listed, and why it was replaced. We will only reimburse customers if the harness was defective as listed in this bulletin.
2. Receipt of payment showing the amount that was paid for the replacement.
3. Complete the reimbursement form. If the customer has misplaced the reimbursement form, copy the form on the back of this page and provide it to him/her.
4. Send in the documents to Porsche Cars North America, attention W301 Customer Reimbursement. We will review the documents and determine if a check will be issued.
5. Porsche Cars North America will not reimburse for incidental expenses related to the repair or replacement of the wiring harness as described in this Service Action.

Porsche Cars North America, Inc.
Attn: W301 Customer Reimbursement
980 Hammond Drive, Suite 1000
Atlanta, Ga. 30328

Important Notice: Porsche Cars N.A. Technical Bulletins are intended for use by professional technicians, not a "Do-it-yourselfer." They are written to inform these technicians of conditions that may occur on some vehicles, or to provide information that could assist in the proper service of a vehicle. Special tools may be required to perform certain operations identified in these bulletins. Use of tools and procedures other than those recommended in these bulletins may be detrimental to the safe operation of your vehicle. Properly trained technicians have the equipment, tools, safety instructions and know-how to do a job properly and safely. If a condition is described, do not assume that the bulletin applies to your vehicle, or that your vehicle will have that condition. See your Porsche Dealer for information on whether your vehicle may benefit from the information. Part numbers listed in these bulletins are for reference only. Always check with your authorized Porsche dealer to verify correct part numbers.

©2002 Porsche Cars North America, Inc.

Dealership	Service Manager _____	Shop Foreman _____	Service Technician _____	_____	_____
Distribution	Asst. Manager _____	Warranty Admin. _____	Service Technician _____	_____	_____
Routing					

Porsche, the Porsche marque, 911, Carrera, Boxster, Cayenne, Tiptronic, VarioCam, VarioRam, Varrera, Tequipment, PCCB, PCNA EDCS, and PCM are registered trademarks. The distinctive shapes of the Porsche automobiles are trademarks of Dr. Ing. h.c.F. Porsche AG.

©2002 Porsche Cars North America, Inc.

Service

Date: 10-18-02
Page 7 of 30

9 911 Turbo (993)
9752 2/01

Technical Information



Customer Reimbursement Application Form – Service Action W301

To Ensure Prompt turn around, please complete all required fields and include a copy of the paid invoice.

Although repairs to the wiring harness were previously completed, it is extremely important to have the wiring harness inspected and, if necessary, replaced at your local Porsche Dealership. If you have not completed this Service Action, Porsche Cars North America cannot issue a reimbursement for past repairs. Please complete the section below and provide a copy of your current invoice. We will only issue a reimbursement if the wiring harness was defective as described in this Service Action. Porsche Cars North America will not reimburse for incidental expenses related to the repair or replacement of the wiring harness as described in this Service Action. Thank you.

Current Inspection/Repair Information:

Date of Repair: _____ Mileage/Kilometers: _____
Dealer Name: _____ Repair Order Number: _____

Owner Information: Vehicle Identification Number (VIN): _____

Current Owner? Yes No If "No", was vehicle sold to a Dealer or private person? Yes No

If known, please provide address of new owner:

New Owner Name: _____
Address: _____
City: _____ State/Prov.: _____ Zip/Postal Code: _____
Your Name: _____
Address: _____
City: _____ State/Prov.: _____ Zip/Postal Code: _____
Home Phone #: _____ Work Phone #: _____

Previous Repair Information: (Important: Please attach copy of paid invoice.)

Date of Repair: _____ Mileage/Kilometers: _____
Dealer Name: _____ Repair Order Number: _____

Independent Repair Facility: Yes No (Please Check One)

Reimbursement Information: (Check One) Total reimbursement requested: \$ _____

Labor Only Parts and Labor

Important Note: Only labor and parts needed to replace the wiring harness (or applicable repairs) will be considered for reimbursement and must be fair and reasonable. Please allow up to six weeks to process your request. **Incomplete forms will be returned**

Porsche Cars North America Review and Comments:

Check Number: _____ Claim Submission Date: _____

Date Check Issued: _____ Amount of Check: _____

Table of Contents

9 Electrical system

97 Wiring

97 52 55	Replacing the wiring harness for the turbocharged engine	97-2	page 1
	Check the wiring harness for the engine	97-2	page 1
	Wiring harness connections	97-2	page 2
	Remove the wiring harness for the engine	97-2	page 4
	Installing the wiring harness for the engine	97-2	page 13

Table of Contents

Printed in Germany, 2002

master

Replacing the wiring harness for the turbocharged engine

Check the wiring harness for the engine

1. Protect the protruding upper part of the lock on the engine compartment lid, for example with a piece of hose (danger of injury). Put rear assembly-protection cover on the vehicle.
2. Remove air guide bracket from the charge air cooler.

Note!

- ◆ The rear fastening nuts of the lower charge air cooler mounting can fall to the floor after they have been unscrewed.
- ◆ The pressure pipes between the charge air cooler and turbo-charger must be sealed (foreign objects).

3. Remove charge air cooler.
4. Remove the cover from the relay carrier in the engine compartment. Unscrew the three screws **-arrows-** for this purpose.

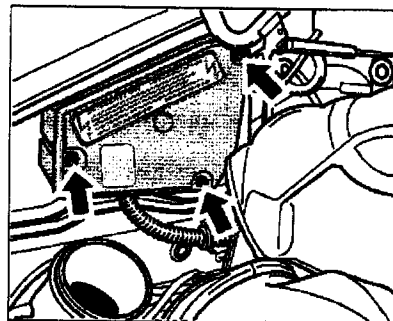

5. Check the part number of the wiring harness. The part number is affixed to the wiring harness **-arrow-** in the relay carrier in the engine compartment. If one of the following part numbers has been printed on the wiring harness or if the part numbers can no longer be read, the wiring harness for the engine must be replaced.

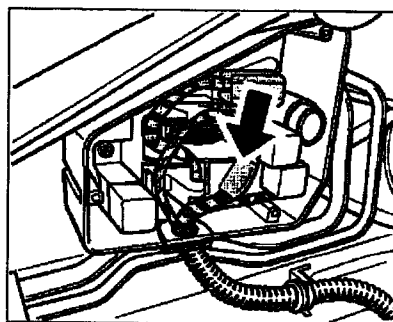

Replace the wiring harness if any of the following part numbers match

	Part number
1	993.607.016.11

Wiring harness connections

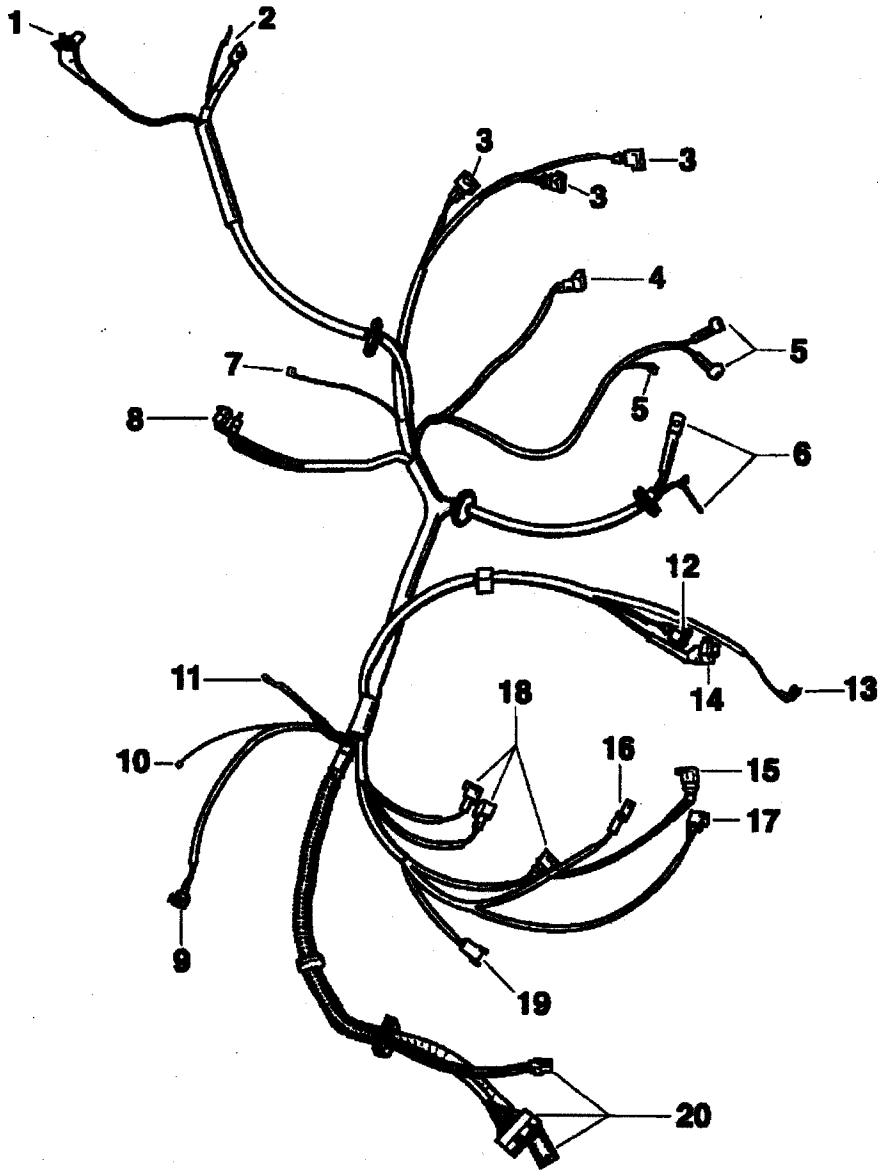

No.	Designation	Qty.	Removal	Installation
1	Reversing light switch connections	2		
2	Starter connections	2	Disconnect battery	
3	Injection valve connections 4 - 6	3		Cyl. 6 = blue; Cyl. 5 = brown; Cyl. 4 = white
4	Frequency valve connection	1		
5	Oil pressure sensor connections	1		
6	Generator connections	3	Disconnect battery	Make sure the cable sleeves are installed correctly.
7	Oil temperature sensor connection	1		
8	Secondary air pump connections	2		
9	Tank vent connection	1		
10	Boost pressure sensor connection			
11	Ground cable	1		
12	Fan belt monitoring connection	1		
13	Connections for ignition coil	2		
14	Hall sender connection	1		
15	Connection, heating switch-over valve	1		
16	Connection, heating ballast resistor			
17	Connection NTC heater blower	1		
18	Injection valve connections 1 - 3	3		Cyl. 3 = blue; Cyl. 2 = brown; Cyl. 1 = white
19	Fresh-air blower connection	1		
20	Wiring harness connecting plug	3	Disconnect battery	

97 52 55 Replacing the wiring harness for the turbocharged engine

97-2 page 3

Printed in Germany, 2002

993-Turbo

⚠ Caution!

Danger of material damage if the vehicle is raised incorrectly!

- ◆ **Raise the vehicle at the prescribed jacking points!**

⚠ Caution!

Risk of damage!

- ◆ **The battery must be disconnected when working on electrical components.**

Remove the wiring harness for the engine

ℹ Note!

- ◆ *Since the Motronik has several adaptive systems, terminal 26 of the DME connector is permanently positive.*
 - ◆ *If the connector is disconnected from the control module or if the vehicle battery is disconnected, the engine must first run 250 seconds before the first adaptation phase begins.*
 - ◆ *The DME control module also has a non-volatile fault memory. Therefore, before disconnecting the battery, the fault memory must be read out and the radio code must be found out!*
1. Disconnect the battery and cover terminal or battery.
 2. Remove the heater blower or bypass air flap, disconnect the ballast resistor on the heating pipe, and clip it in again.
 3. Remove the cover from the relay carrier in the engine compartment. Disconnect the plug connections carefully (risk of breakage). Counter when pulling off.

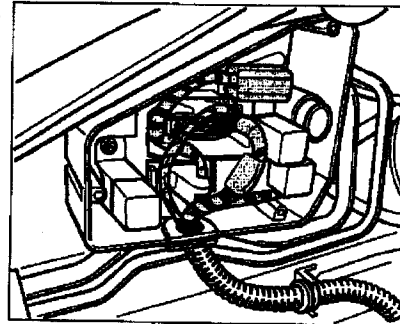

4. Remove the air cleaner assembly and hot film air flow sensor. Disconnect the air flow sensor from the air cleaner housing. Take the air cleaner housing out of the rubber mounts. Unplug the air flow sensor and disconnect from the air cleaner housing by turning.

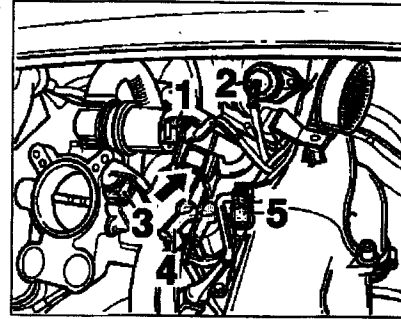

- 1 - Idle speed control connection
- 2 - Air flow sensor connection
- 3 - Air-conditioning lines holder
- 4 - Oil pressure sensor connections
- 5 - Boost air temperature sensor connector

5. Remove the positive crankcase ventilation hose -arrow-.

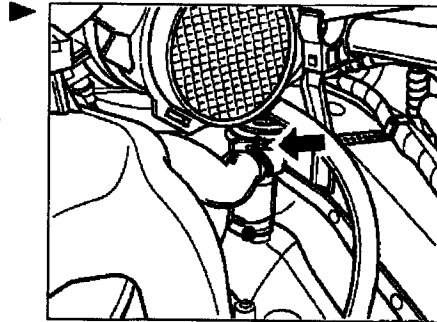

 **Note!**

The square fastening nuts of the air conditioning compressor holder screws can fall to the floor after they have been unscrewed.

6. Unscrew the four air conditioning compressor holder screws and release the clamp. Disconnect the plug connections and set the air conditioning compressor with a stable base down on the right side section.

7. Release the upper hose clamps (6 pieces / 3 left and 3 right) of the intake pipes.

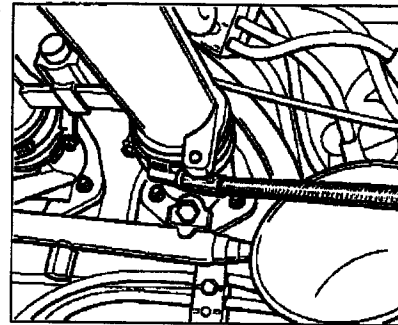

8. Disconnect the connector from the holder and release the hose ► from the tank vent -arrow- and remove.

- 1- Temperature sensor connection
- 2- Reference mark sender connection
- 3- Tank vent connection
- 4- Cruise control connection

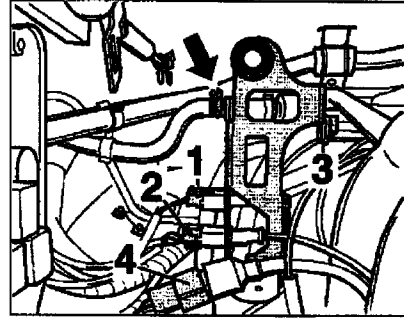

9. Disengage the accelerator cables -arrows- and unscrew the ► screw of the counter holder. Press the accelerator cables out of the holder. Pull off the hose -1-.

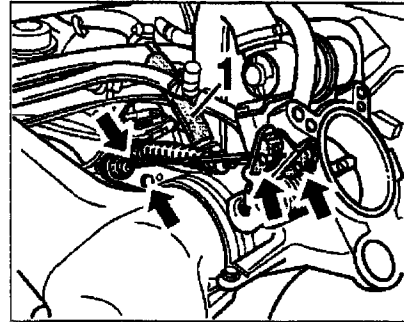

10. Remove the center and right vent hose on the throttle body. ►

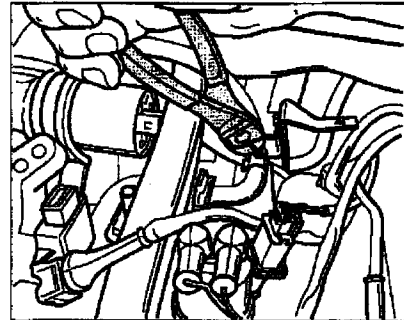

Vent hose

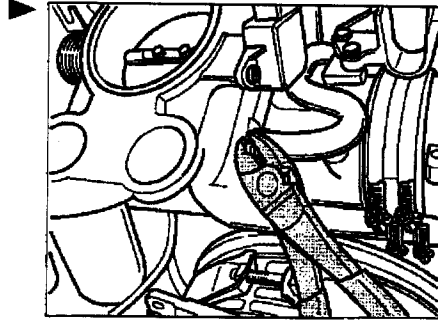

11. Unscrew the screws -1- of the oil pressure sensor, disconnect the connector and disconnect the ground strap -arrow-. Lay the oil pressure sensor aside.

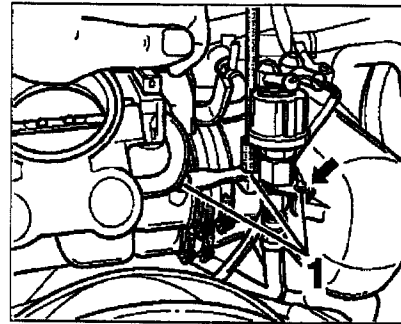

12. Pull all vacuum connections and connectors on the intake distributor. Remove the vent hose -1-. Mark the vacuum connections.

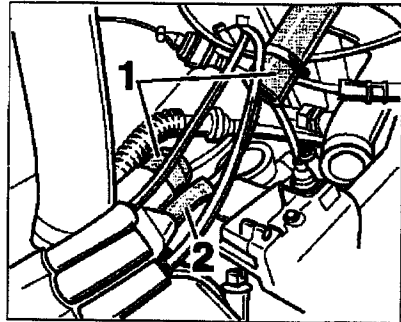

1 check valve

Note!

All intake pipes must be sealed (foreign objects).

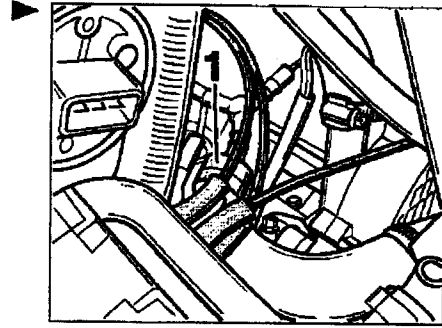

13. Remove the complete intake distributor (right, left, and center) ▶

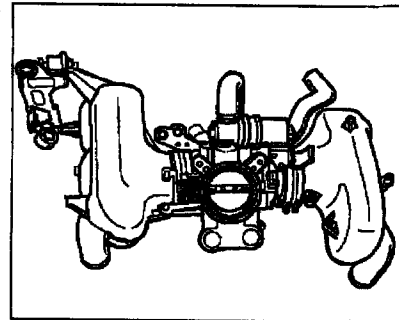

14. Remove the two rubberized clamps of the wiring harness. ▶

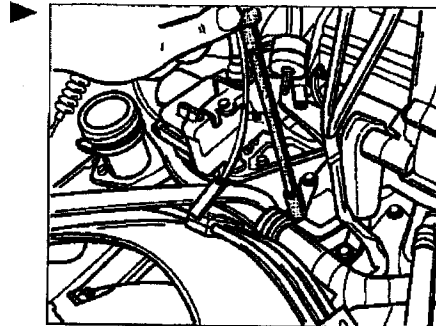

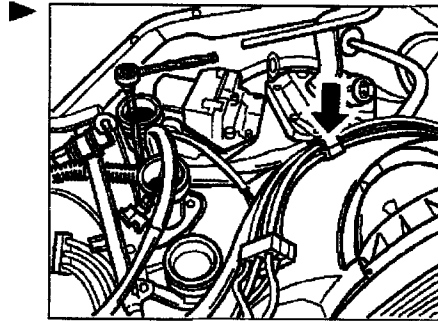
Rubberized clamp

15. Release the ground cable from the intake pipe.

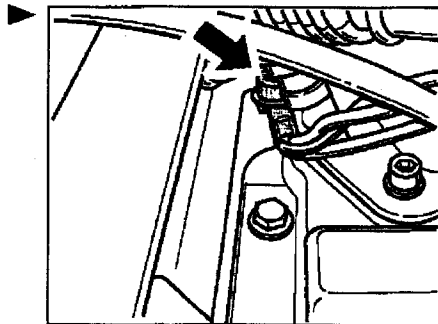

16. Disconnect the connector from the fan belt monitoring and remove the fan belt monitor.

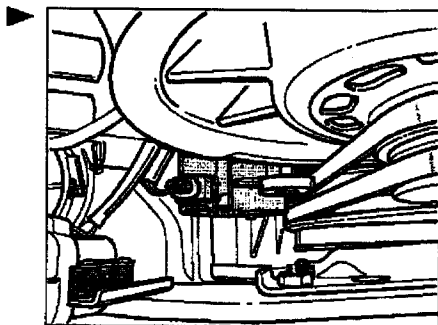

17. Remove the air cowl of the cooling fan. Unscrew the 3 screws and remove the air cowl.

18. Release the cooling fan restraining strap and unscrew the screw. Tilt the cooling fan forward.

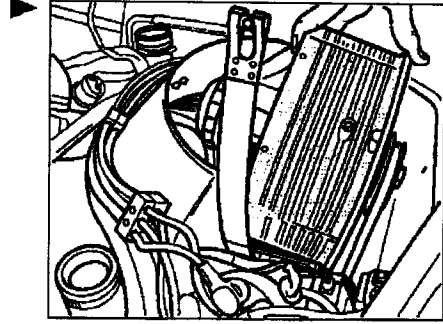

19. Unscrew the generator housing screws. Release the cable from the generator. Press the rubber grommet out of the air cowl and pull out the lines.

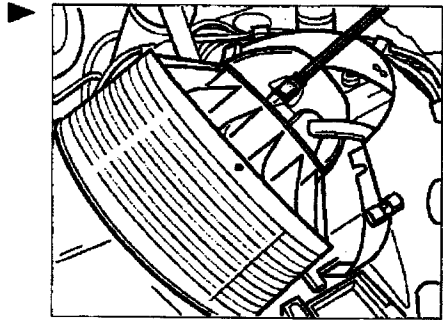

20. Release the ignition wire retainer and unclip the fastening clip.

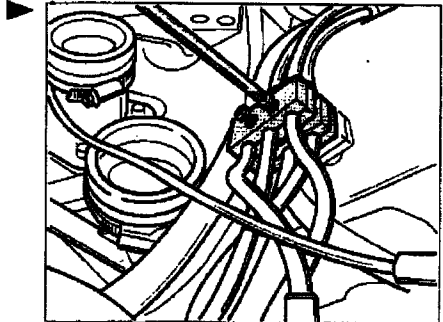

21. Unscrew the two screws of the fuel gallery on the right and pull out the tab washers of the injection valve. Then push the fuel gallery lightly toward the rear.
22. Unplug the connectors from the injection valves, distributor ignition, ignition coil (connections are screwed in), oil pressure sensor (connections are screwed in), oil temperature sensor and secondary air pump.
23. Pull the wiring harness approx. 100 mm under the crankcase vent tube toward the passenger compartment.
24. Remove thermal motor protection.

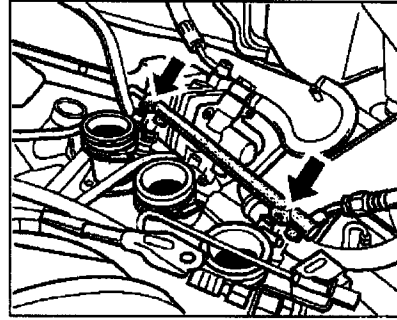

25. Remove the warm air pipe on the right -arrows-. To do this, unscrew the two hexagon socket head bolts and release the hose straps.

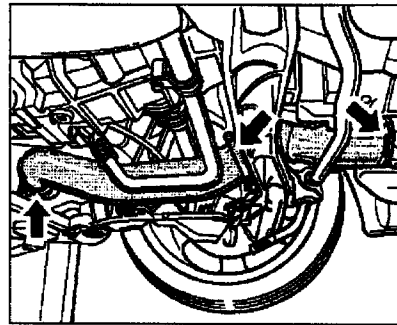

26. Remove the transmission vent hose and suction hose to the turbocharger. To do so, release the upper screw-type hose clamp -arrow- and the lower clamp -arrow-.

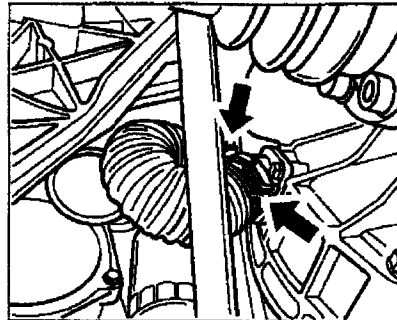

97 52 55 Replacing the wiring harness for the turbocharged engine

Printed in Germany, 2002

993-Turbo

97-2 page 11

27. Unscrew the ground cable **-arrow-** on the starter. To do this, unscrew the hexagon socket nut.

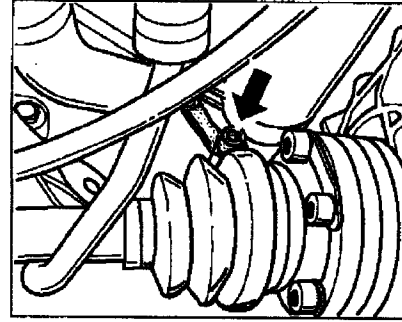

28. Release the connections from the starter **-1 + 2-** and cut off the 2 tie-wraps **-arrow-**.

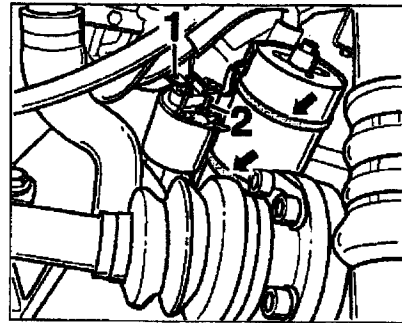

29. Pull out reversing switch connector. To do this, pull out the rubber grommet and the two pins.

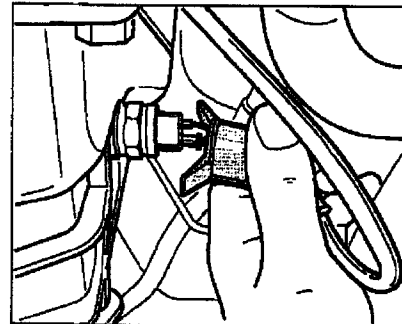

30. Pull out rubber grommet **-arrow-** from the wiring harness. ▶

- 1 - Wiring harness for the starter and reversing light switch
- 2 - Wiring harness for the fuel distributor pipe

Note!

Carefully press the wiring harness past the pipes. Avoid damage.

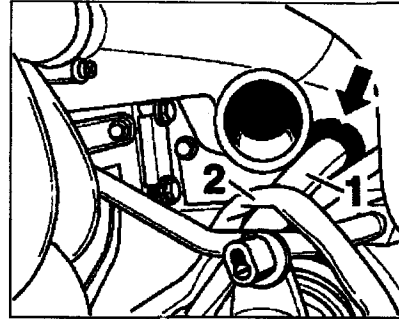

31. Pull wiring harness up and out. Doing this requires a second person. One person must press the wiring harness from below through the opening in the engine compartment while the other person pulls the wiring harness out. ▶

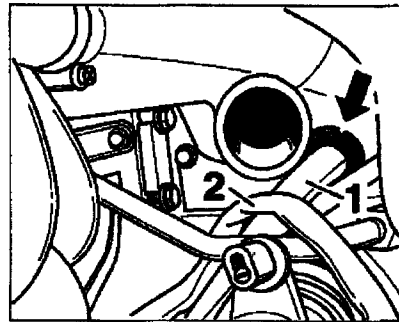

Installing the wiring harness for the engine

1. Feed the wiring harness through the opening in the engine compartment to the starter and reversing light switch.

Note!

The terminal 30 cable must be bound with the protective tube with two tie-wraps to the starter. Attach the protective caps to the cable clamp.

2. Screw in the connections on the starter **-1 + 2-** and tighten. ▶
Fasten the two tie-wraps **-arrows-**.

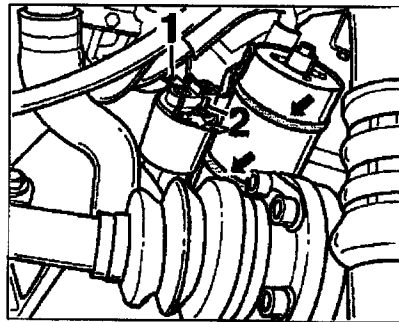

3. Insert the reversing light switch connector. To do this, press in the two pins and mount the rubber grommet. ▶

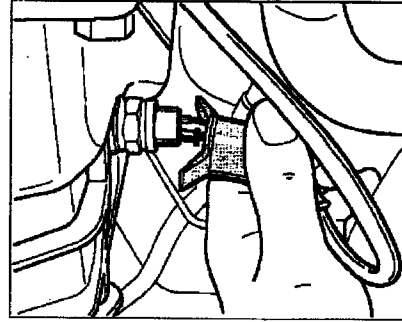

4. Fasten the ground cable -arrow- on the starter. Tighten the hexagon socket nut. ▶

Tightening torque hexagon socket nut 46 Nm (34 ftlb.).

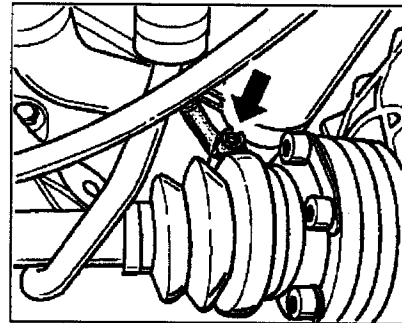

5. Install the transmission vent hose and suction hose to the turbocharger. To do so, fasten the upper screw-type hose clamp -arrow- and the lower clamp -arrow-. ▶

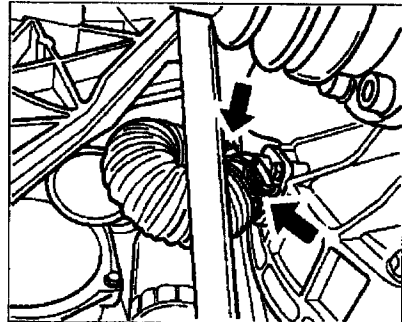

6. Install warm air pipe on right -arrow-.

Tightening torque (M6 x 20, M6 x 12) 10 Nm (7.5 ftlb.)

7. Install thermal motor protection.

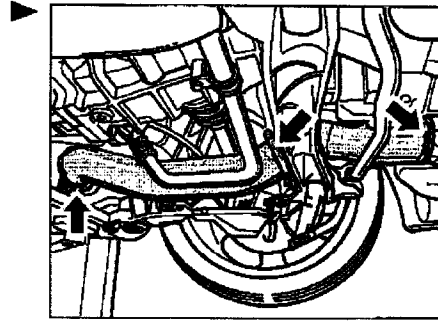

8. Guide wiring harness under the crankcase vent tube.

1 - Line to starter and reversing light switch

2 - Line to the fuel distributor pipe

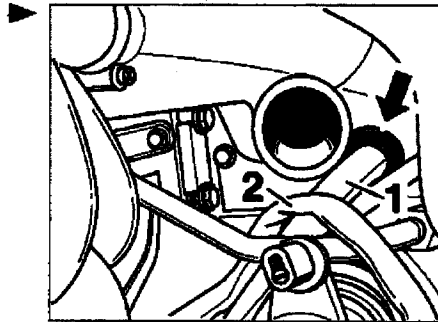

9. Lightly lubricate the rubber grommet -arrow- of the wiring harness and press it in. Ensure correct seating.

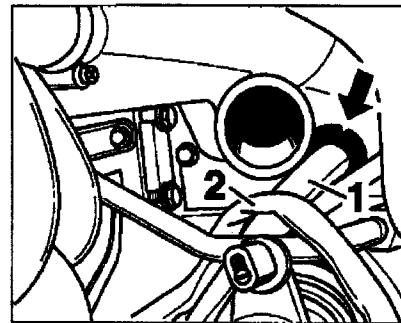

97 52 55 Replacing the wiring harness for the turbocharged engine

Printed in Germany, 2002

993-Turbo

97-2 page 15

Note!

Check the sealing rings of the injection valves, replace as necessary and lubricate (e.g., WD 40).

10. Position the screws -arrows- of the right fuel gallery and tighten. Install the tab washers of the injection valves. Ensure that the tab washers are seated correctly.

Tightening torque 10 Nm (7.5 ftlb.).

11. Connectors of the injection valves cyl. 4 - 6 are connected and the wiring harness is fastened to the fuel gallery.

Connector color	Cylinder
blue	6
brown	5
white	4

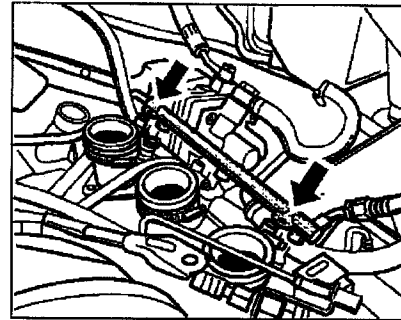

12. Guide the generator connection cable through the air cowl and press in the rubber grommet. Place the cable on the generator, lubricate slightly, and fasten. Press rubber grommet in the air cowl. Position generator cover and tighten.

Tightening torques

D+ cable (blue) 2 Nm (1.5 ftlb.), D- cable (brown) 2 Nm (1.5 ftlb.), and the B+ cable (red) 8 Nm (6 ftlb.)

Fastening screws generator housing 10 Nm (7.5 ftlb.).

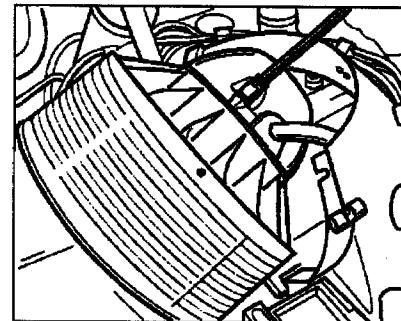

13. Install the cooling fan and tighten the restraining strap with a hexagon socket head bolt.

Tightening torque 8 Nm (6 ftlb.)

14. Install the air cowl of the cooling fan. Tighten the screws.

Tightening torque 10 Nm (7.5 ftlb.)

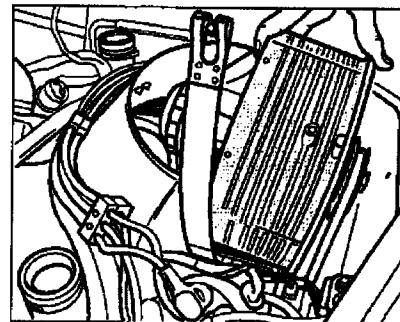

15. Install fan belt monitor and unplug connector.

Tightening torque 10 Nm (7.5 ftlb.).

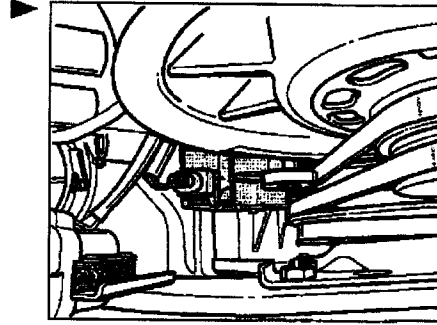

16. Slide the wiring harness holder on the holder of the ignition coil cable and fasten.

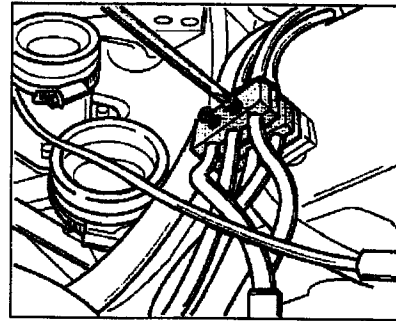

17. Fasten the wiring harness using the two rubberized clamps.

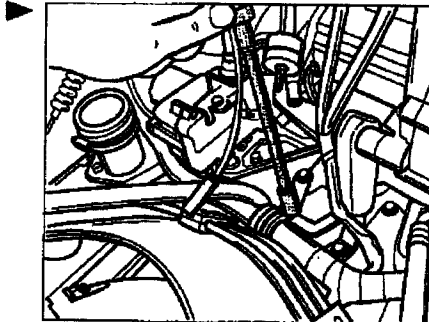

97 52 55 Replacing the wiring harness for the turbocharged engine

Printed in Germany, 2002

993-Turbo

97-2 page 17

Rubberized clamp

Tightening torque for hexagon-head bolts 10 Nm (7.5 ftlb.)

18. Position and tighten ground cable on the intake pipes.

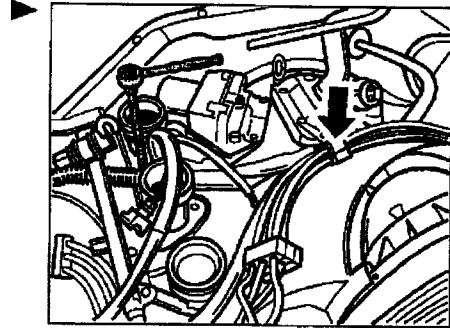

Tightening torque 10 Nm (7.5 ftlb.).

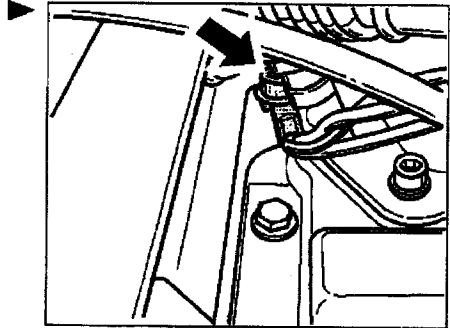

19. Insert the plug connections from the relay carrier into the engine compartment and mount the cover.

20. Connect the connectors of the injection valves 1 - 3, distributor ignition, ignition coil (connections are screwed in), oil pressure sensor (connections are screwed in), oil temperature sensor and secondary air pump.

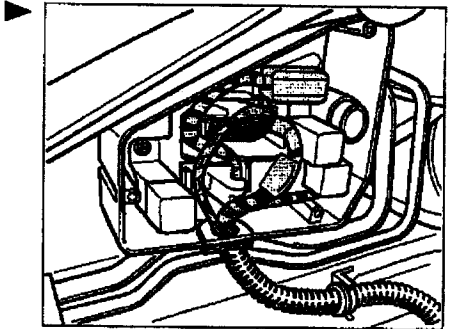

Connector color	Cylinder
blue	3
brown	2
white	1

21. Install the complete intake distributor (right, left, and center). Lightly oil the rubber of the intake pipes. Tighten the hose straps of the intake pipes.

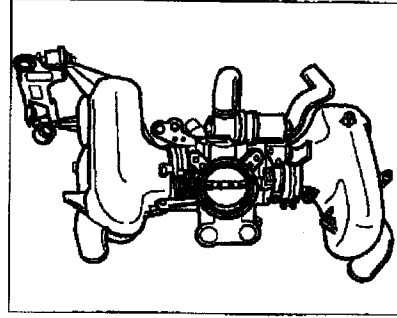

22. Connect all vacuum connections and connectors on the intake distributor.

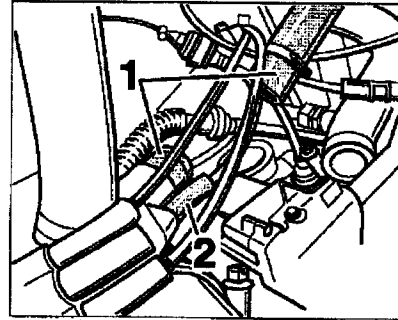

23. Connect the center and right vent hose on the throttle body.

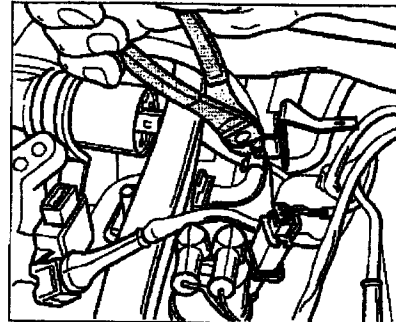

Vent hose

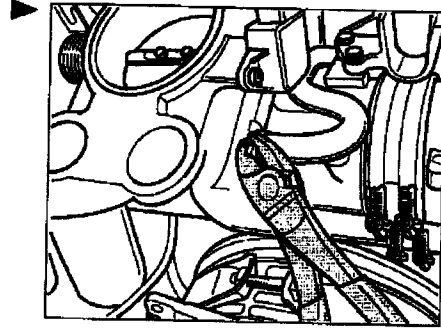

24. Place the oil pressure sensor holder and tighten the screws -1-. Fasten the ground strap -arrow-.

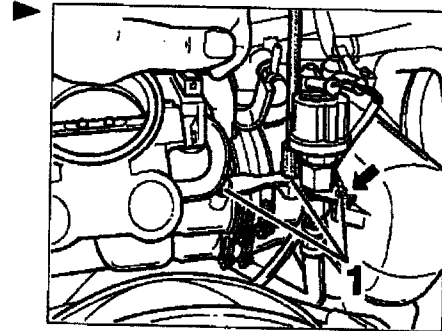

25. Engage accelerator cables -arrows-. Lightly oil the rubber of the accelerator cables. Tighten the accelerator cable holder. Connect the hose -1-. Ensure that the accelerator cables are seated correctly and tightly.

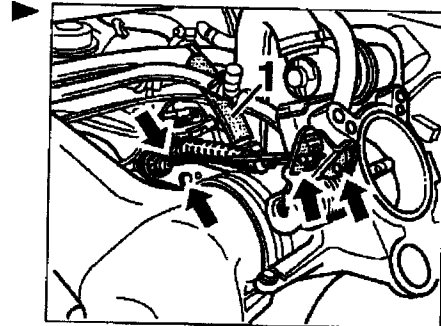

Tightening torque 10 Nm (7.5 ftlb.).

26. Fasten the connector on the holder (observe color code). Position and tighten the hose from the tank vent -arrow-.

- 1 - Temperature sensor connection
- 2 - Reference mark sender connection
- 3 - Tank vent connection
- 4 - Cruise control connection

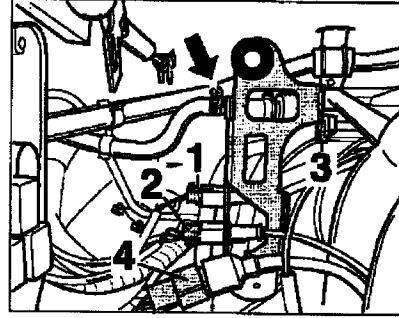

27. Install air-conditioning compressor. Connect connector. Position screws and tighten. Fasten air-conditioning lines in the holder.

Tightening torque 28 Nm (21 ftlb.)

- 28. Mount the positive crankcase ventilation hose -arrow-.
- 29. Install the air cleaner assembly and hot film air flow sensor.
- 30. Mount the heater blower or the bypass air flap.
- 31. Install charge air cooler.
- 32. Mount the air guide bracket from the charge air cooler.
- 33. Connect the battery.

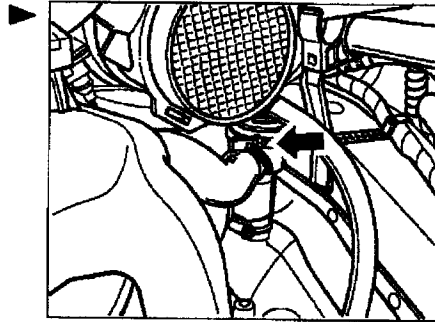

Note!

After the connector has been disconnected from the control module or if the vehicle battery has been disconnected, the engine must first run 250 seconds before the first adaptation phase begins.

- 34. Perform a function test.